



*Versati™ Tabletop Centrifuge Models: TCV-1500 and TCR-1500*



*Versati™ Micro Centrifuge Models: MCV-88 and MCR-88*

# Versati™

## Centrifuge

*Best Choice for High Performance and Superior Quality Centrifuge*

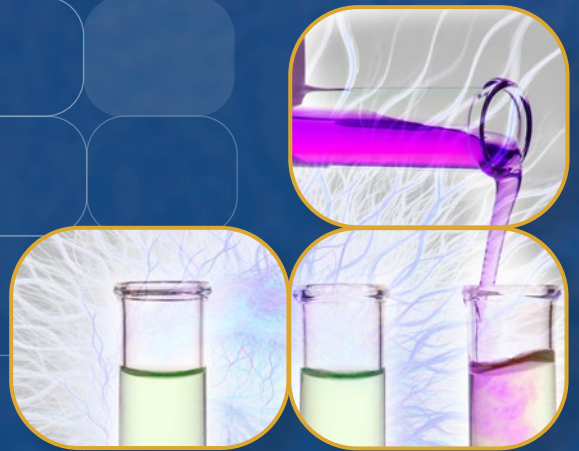



# Welcome to Esco Lifesciences

Esco Lifesciences' vision is to provide enabling technologies for scientific discoveries to make human lives healthier and safer.

Esco Lifesciences is committed to delivering innovative solutions for the clinical, life sciences, research, industrial, laboratory, pharmaceutical, and IVF communities. With the most extensive product line in the industry, Esco has passed a number of international standards and certifications. Esco Lifesciences represents innovation and forward-thinking designs, that are of the highest standard quality since 1978.

**Availability and Accessibility.** Esco Lifesciences has headquarters in Singapore, Indonesia, and Philippines, with manufacturing facilities located in Asia and Europe. Research and Development (R&D) is conducted worldwide spanning the US, Europe and Asia. Sales, services, and marketing subsidiaries are located in 42 major markets including US, UK, Japan, China and India. Esco regional distribution centers are located in Singapore, Malaysia, Thailand, Vietnam, Myanmar, Indonesia, Philippines, Bangladesh, Hong Kong, Taiwan, South Korea, China, Japan, India, UAE, Central and South Africa, Denmark, Germany, Italy, Lithuania, Russia, United Kingdom, and USA. Because of our worldwide presence, you can be sure that Esco is within your reach.

**High Quality, Reliable, and Dependable.** Esco Lifesciences products are of high quality, reliable, and dependable. Cross-functional teams from Esco Production, R&D, Quality Assurance, and Senior Management, are regularly assembled to review and implement areas for improvement.

**Esco Lifesciences Cares for Your Safety.** Esco Lifesciences focuses on providing safety not just for your samples, but also for you and the environment.

**Esco Lifesciences Cares for Your Comfort.** Building ergonomic designs and reducing noise levels of the units ensure comfort for our users.

**Esco Lifesciences Cares for the Environment.** Esco Lifesciences incorporates the latest proven technologically advanced components available. One in every four of Esco's employees is involved in Research and Development and are evaluating new components or designs for better efficiency. Whenever a new technology is available, Esco Lifesciences redesigns technology into our new products that will use lesser energy.

**Customer Service and Support.** Our service does not stop once purchase has been done. Esco Lifesciences gives on-time customer service such as service training, preventive maintenance, and re-certification, to respond to your equipment needs. Esco Lifesciences also offers free end-user seminars and provides educational materials and informative videos.

As Esco Lifesciences takes the opportunity to respond to the world's needs, we aim not only to contribute to the advancement of scientific discoveries but also in making the world a safer, healthier, and better place to live in.



# Products and Applications

## Life Sciences Laboratory Equipment

### Sample Preparation

- Class I Biological Safety Cabinets
- Class II Biological Safety Cabinets
- Class II Type A2 Biological Safety Cabinets
- Class II Type B1 Biological Safety Cabinets
- Class II Type B2 Biological Safety Cabinets
- Class III Biological Safety Cabinets
- Horizontal Laminar Flow Cabinets
- Vertical Laminar Flow Cabinets
- Laboratory Animal Research Workstations
- Laboratory Centrifuges

### Sample Cultivation

- CO<sub>2</sub> Incubators, Direct Heat Air-Jacketed
- CO<sub>2</sub> Incubators with Cooling System
- CO<sub>2</sub> Incubators with Stainless Steel Exterior
- Laboratory Shakers

### Sample Handling and Analysis

#### PCR Thermal Cyclers

- Conventional Thermal Cyclers

#### PCR Sample Handling

- Microplate Shakers
- PCR Cabinets

### Sample Storage & Sample Protection Solutions

- Ultra-low Temperature Freezers
- Lab Refrigerators and Freezers
- Remote Monitoring, Datalogging, and Programming Software
- Intelligent Remote Monitoring Application Protocol
- Wireless Monitoring System

### Chemical Research

- Ductless Fume Hoods
- Laboratory Fume Hoods
- Fume Hood Airflow Monitors
- Exhaust Blowers
- Powder Weighing Balance Enclosures
- Filtered Storage Cabinet

### General Equipment

#### Laboratory Thermostatic Products

- Laboratory Oven
- Forced Convection Laboratory Incubator
- Natural Convection Laboratory Incubator
- Refrigerated Incubator

### Forensic Sciences

- Evidence Drying Cabinet

## Medical / IVF Equipment

### Sample Handling

- Multi-zone ART Workstation (MAW)
- Multi-zone ART Workstation (MAW) Class II
- Airstream® Laminar Flow Bench
- AVT Anti-Vibration Table
- Versati™ Tabletop Centrifuge Refrigerated

### Embryo Culture

- MIRI® Multiroom Incubator
- MIRI® II-12 Multiroom Incubator
- Mini MIRI® Dry Incubator
- Mini MIRI® Humidity Incubator
- CelCulture® CO<sub>2</sub> Incubator

### Innovative Time-Lapse Imaging

- MIRI® Time-lapse Incubator

### Accurate Quality Control

- MIRI® GA Gas and Temperature Validation Unit

### Unique Consumables

- CultureCoin®

## Healthcare

### Esco Pharma Products

#### Airflow Containment Products

- Pharmacon® Downflow Booths
- Ceiling Laminar Airflow Units
- Laminar Flow Horizontal/Vertical Trolley
- Enterprise™ Laminar Flow Straddle Unites
- Cytoculture™ Cytotoxic Safety Cabinets

#### Isolation Containment

- Aseptic Containment Isolator (ACTI)
- Weighing and Dispensing Containment Isolator (WDCI)
- General Processing Platform Isolator (GPPI)
- Containment Barrier Isolator (CBI)
- Turbulent Flow Aseptic (Grade A) Isolator (TFAI)
- Isoclean® Healthcare Platform Isolator (HPI)
- Streamline® Compounding Isolators (SCI)
- Technetium Dispensing Isolators
- Blood Cell Labeling Isolators
- Open and Closed Restricted Barrier Access Systems (RABS)

#### Cross Contamination Facility Integrated Barrier

- BioPass™ Pass Through
- Infinity® Air Shower Pass Box
- Cleanroom Air Shower
- Infinity® Cleanroom Transfer Hatch
- Infinity® Pass Box
- Soft capsule® Soft Wall Cleanroom
- Dynamic Passboxes and Dynamic Floor Laminar Hatches
- Laminar Flow Storage Cabinet

#### Ventilation Containment

- Ventilated Balance Enclosure

### Esco VacciXcell Products

#### Bioreactors and Fermenters

- CelXrocker™ (CXR)
- CelCradle™ (CC)
- CelCradle X® (CCX)
- TideXcell® (TXL)
- VXL™ Hybrid
- BioXcell®
- StirCradle™
- StirCradle™ PRO

#### Harvesting System

- CelShaker™
- CelCradle X® Semi-automated Harvester (CCX-SAH)
- TideXcell Harvester System (TXLHS)

#### Cell Culture Monitoring, Media and Consumables

- Super Plus™
- Plus™ Vero
- Plus™ MDCK
- Plus™ MDCK II
- BioNOCT™ II macrocarriers
- BioMESH® macrocarriers
- GlucCell™ Glucose Monitoring System
- Crystal Violet Dye (CVD) Nuclear Count Kit

#### Filling Line Equipment

- Traditional Filling Line

#### Integrated Solutions

- Cell Processing Isolator
- Cell Processing Center

### Esco TaPestle Rx Products and Services

#### Pharmacy Automation and Compounding Supply

- Compounding Pharmacy Isolators (SCI, HPI, CBI, GPPI)
- Safety Cabinets and Enclosures (Class II BSC, VBE, LFC)
- Aseptic Filling Systems

#### Radiopharmacy Equipment

- Radioisotope Fume Hood
- Lead-lined Biosafety Cabinet
- Technetium Dispensing Isolator
- Blood Cell Labeling Isolator
- GMP-compliant Radioisotope Dispensing Isolator

Esco offers the best choice for high performance and superior quality centrifuge—Versati™ centrifuges. It is equipped with maintenance-free motors, a durable mechanism, and an intelligent Versati™ microprocessor control system that offers extreme reliability and safety. Versati™ centrifuges have a robust versatility covering micro centrifuge and low-to-high speed general-purpose centrifuge with a variety of rotors, adapters, and accessories to fit all your application needs.

Our micro centrifuge models— MCV (ventilated) and MCR (refrigerated) stand out with their outstanding features. Both have a maximum speed of 15,000 rpm (21,380 x g), a maximum volume capacity of 44 x 1.5/ 2.0 ml, and can accommodate 12 x 5 ml reaction tubes or 4 x 8 PCR strips per run. Additionally, our micro ventilated centrifuge has a hematocrit rotor that can accommodate 24 capillaries per run. Esco Versati™ centrifuges' compact design saves space in your lab and its low noise performance is preferred in any working area. The refrigerated model's powerful refrigeration system keeps samples at a



### DISTINCT CONTROL PANEL AND INTELLIGENT VERSATI™ MICROPROCESSOR CONTROL SYSTEM

- Big rotary knob and buttons, convenient for rotation and operation.
- Large LCD screen with a clear indication of running condition including rotor, speed, time, etc.
- The operation panel is waterproof that can well protect the inner electric elements.
- Microprocessor with speed self-tested system.



### DIVERSE CHOICES OF ROTORS

- Made of aluminum alloy.
- Automatic rotor recognition function (for TCV/TCR only) minimizes the need for manual settings.
- Powerful motor provides high rcf capacity up to 21380 x g for MCV/MCR, 21382 x g for TCV, and 24320 x g for TCR.
- As many as six rotors with a wide range of capacity for MCV, five rotors for MCR, and eleven rotors for TCV/TCR to meet all your needs.



### INTEGRATED DESIGN OF INTERIOR CENTRIFUGE CHAMBER

- The side plate and baseboard of the centrifuge chamber is made by one-time punch forming of a whole piece of steel plate.
- No dead angle within the chamber, easy-to-clean and can reduce pollution at the greatest possibility.



Versati™ Tabletop Centrifuge TCV-1500 and TCR-1500



Versati™ Micro Centrifuge MCV-88 and MCR-88

temperature of as low as 4°C during a continuous run at 21380 x g.

For tabletop centrifuge models, Esco Versati™ Tabletop Ventilated Centrifuge (TCV) and Tabletop Refrigerated Centrifuge (TCR) also excel among the same level of products with their versatility, running features, and easy handling. It can act as different type of centrifuge to meet all your application needs—centrifuge for DNA precipitations, high-capacity and low-to-high speed general-purpose centrifuge for cell application. Both have available fixed-angle and swing-bucket rotors with a maximum capacity of up to 6 x 250 ml (for fixed-angle rotor) and 4 x 250 ml (for swing-bucket rotor). In addition, both have an available microtiter plate rotor with maximum capacity of up to 6 plates. The tabletop ventilated centrifuge maximum speed and rcf is 15,000 rpm (21,382 x g) while the tabletop refrigerated centrifuge maximum speed and rcf is 16,000 rpm (24,320 x g).

### SAFETY LID LOCK

- *Motor-driven lid lock ensures safety and reliability.*
- *The lid can be opened only when the rotor stops and the speed indicator is 0.*
- *Smooth, automatic, and electromagnetic lid allows one-hand-operation*



### EMERGENCY SWITCH

- *In case of power failure or malfunction, the lid of the centrifuge can be opened manually via the emergency switch in order to protect your samples.*



### MAINTENANCE-FREE, BRUSHLESS MOTOR

- *Equipped with German-originated motor, requiring neither bearing replacement nor change oil.*
- *No carbon brush, low interference. Electric spark-free that ensures no interference to radio equipment.*
- *Low noise and smooth operation with superior mechanism design.*
- *Prolongs the lifespan and saves maintenance costs.*



### POLISHED AND PRACTICAL APPEARANCE

- *External surfaces are powder coated Esco Isocide™ to eliminate 99.9% of surface bacteria within 24 hours of exposure. This technology ensures relatively aseptic condition.*
- *Provides healthier, safer, and cleaner lab environment.*

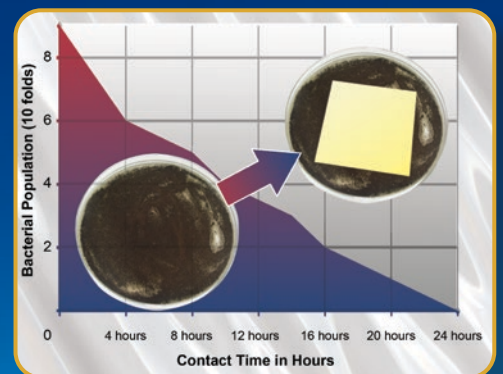

## TCV Engineering Drawing

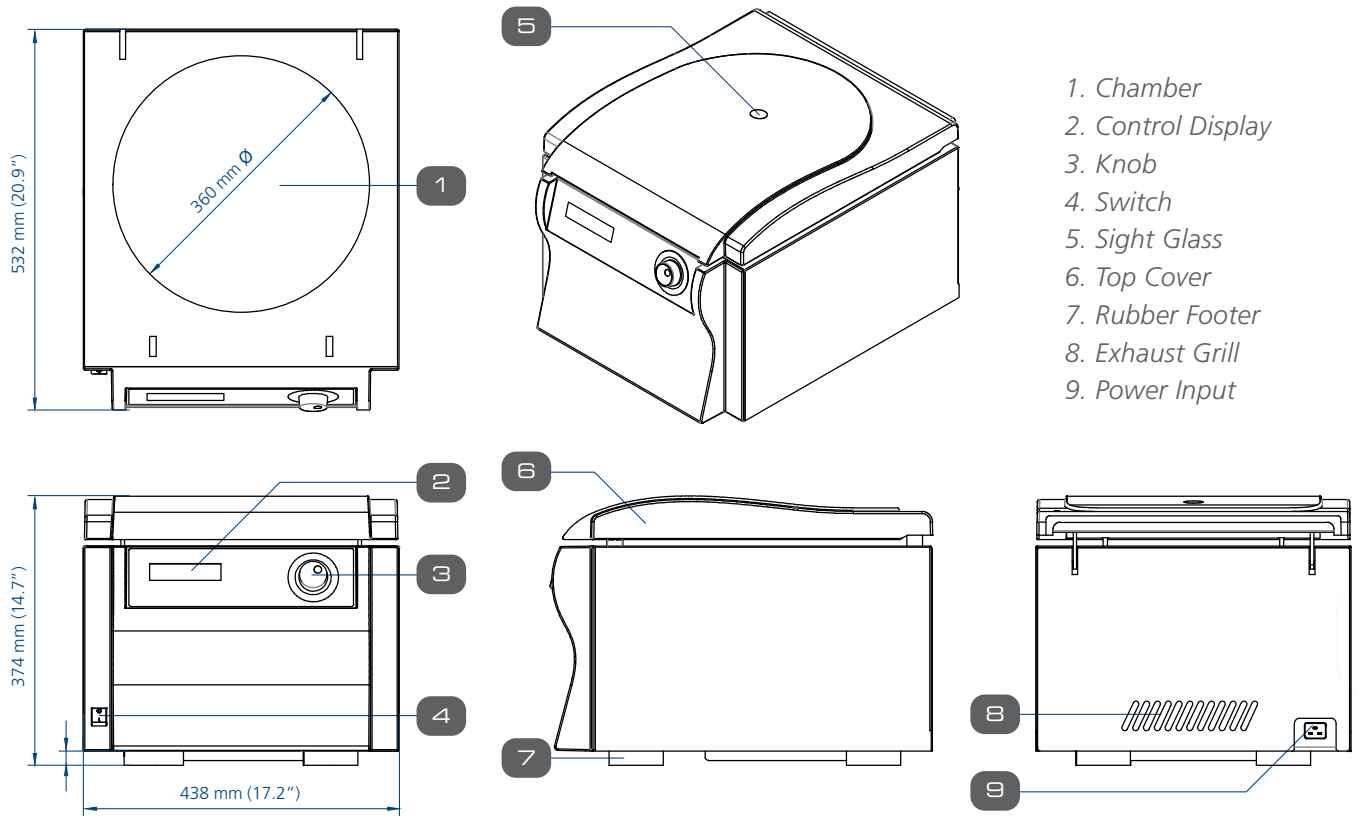

## TCR Engineering Drawing

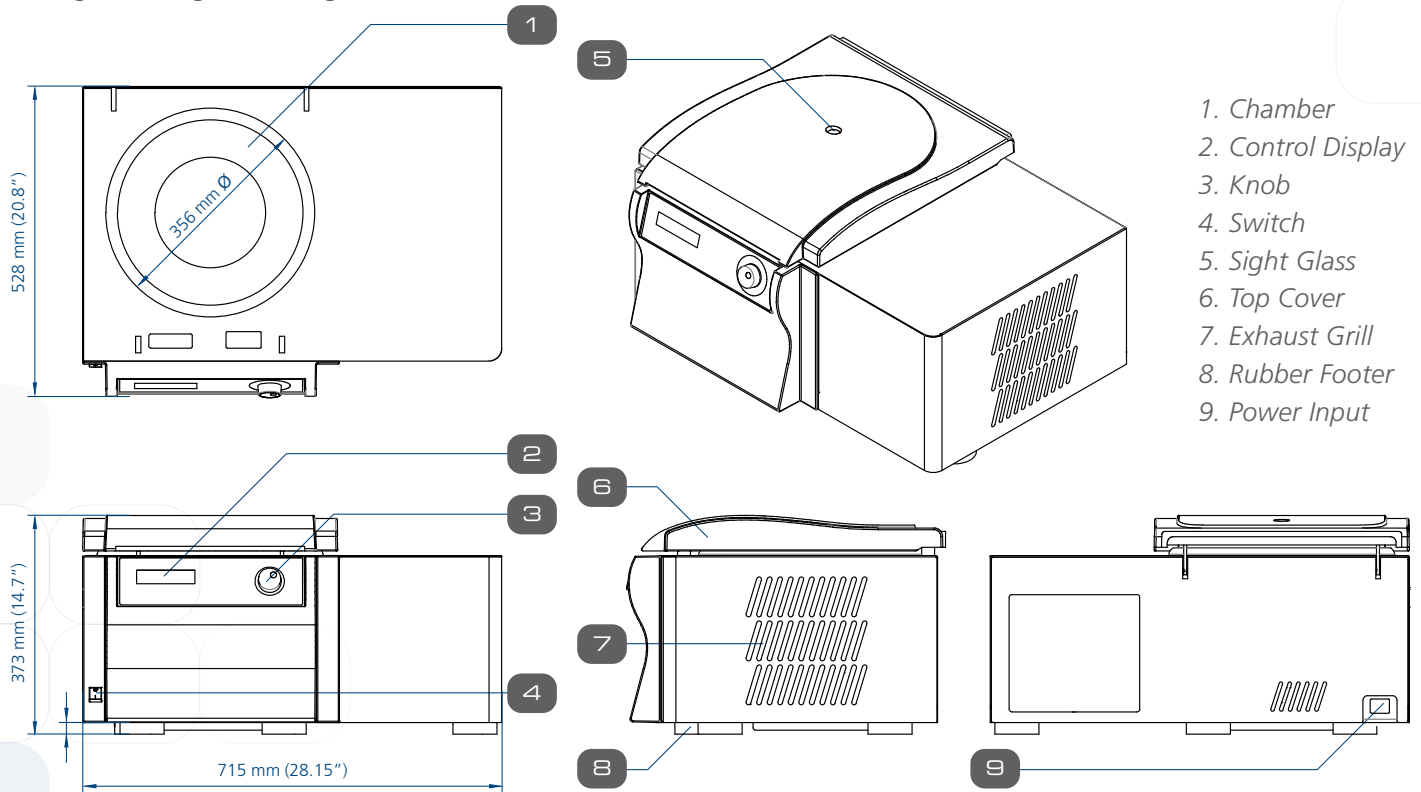

## MCV Engineering Drawing

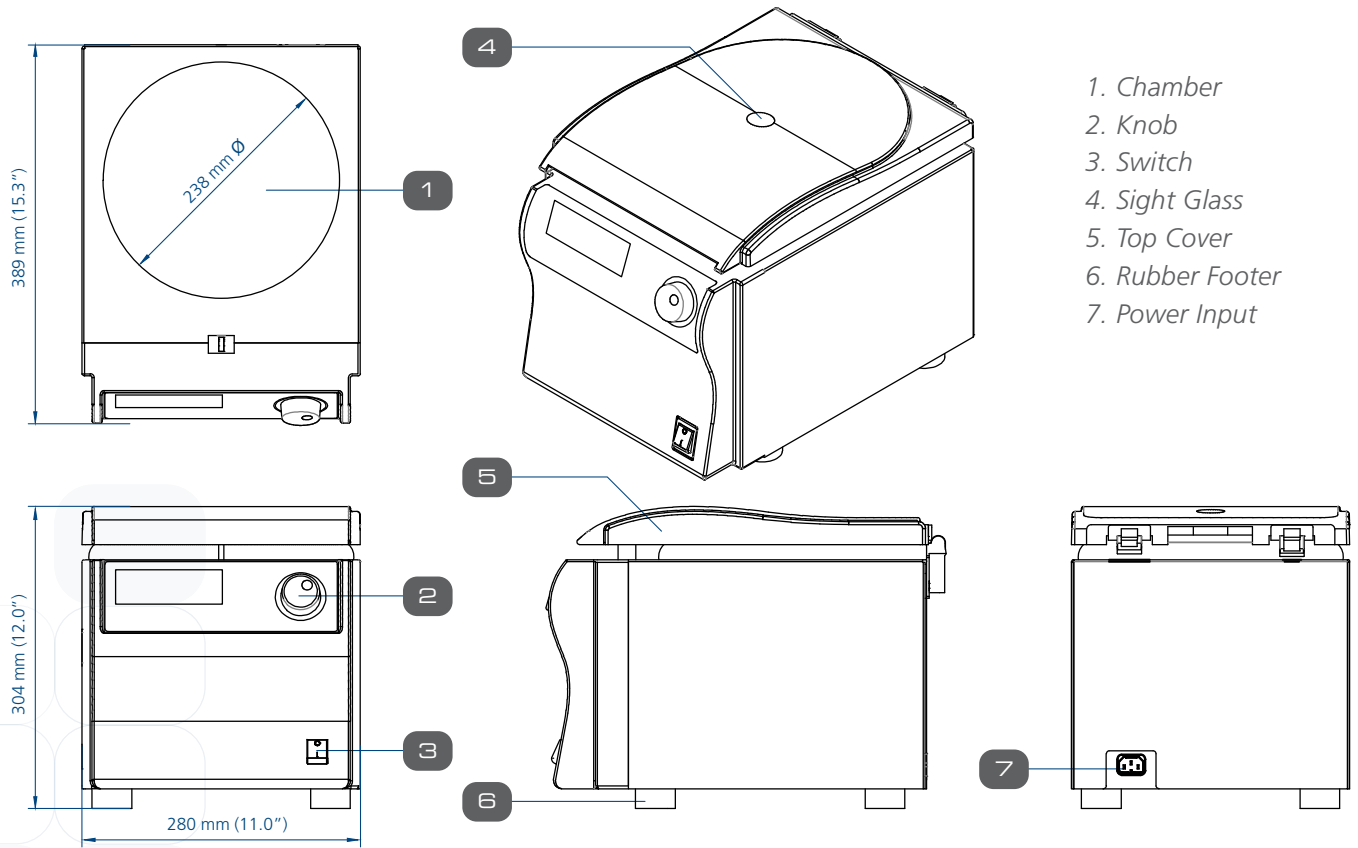

## MCR Engineering Drawing

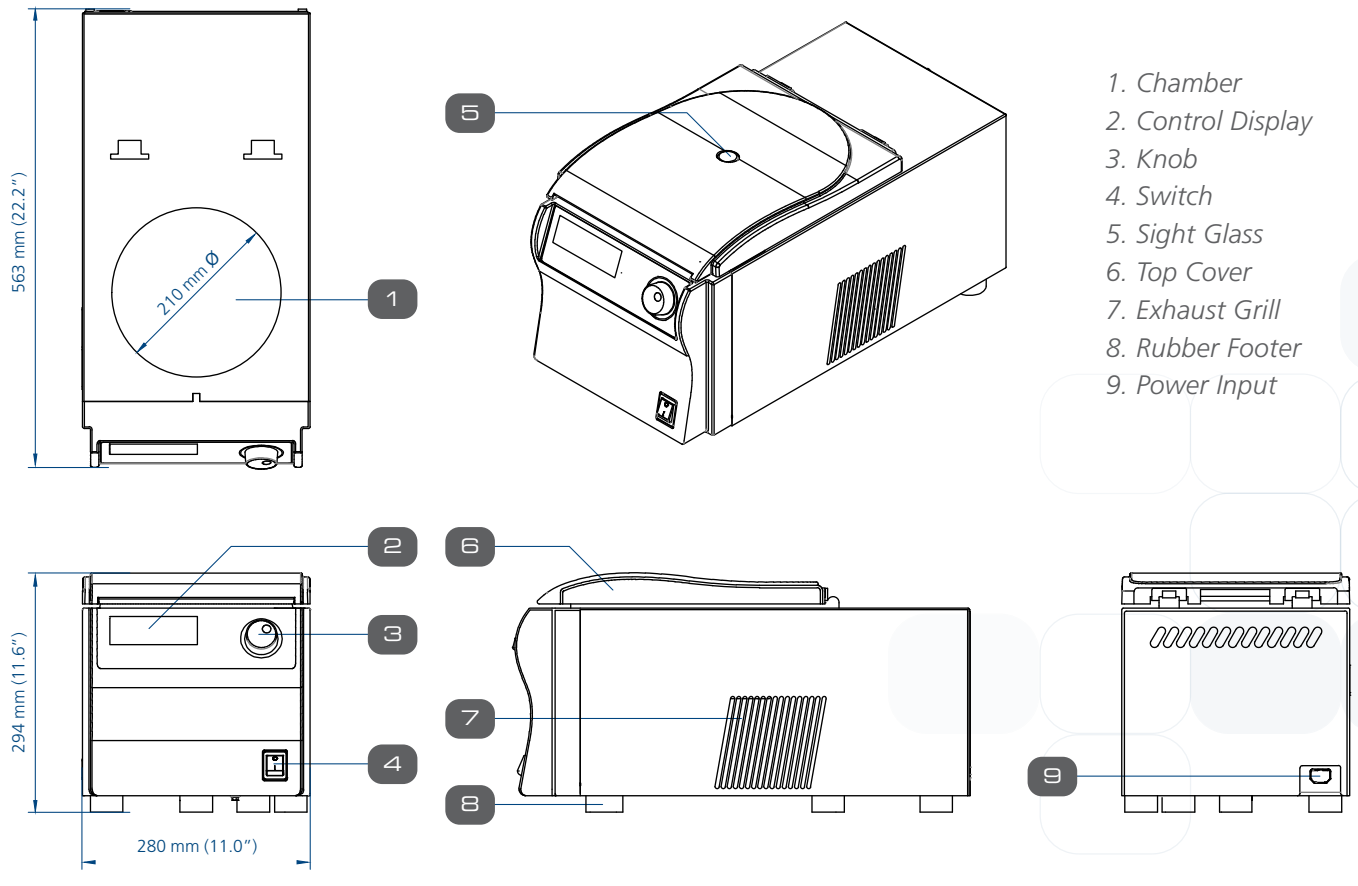

## Versati and Outstanding Features

Based on German manufacturing technology, especially in motor and rotor design, Versati™ centrifuges have elaborate mechanical performance not only in speed but also in flexibility and versatility.

- **Compact Design**

- Exceptional capability in compact dimensions maximizes workspace.
- Small footprint and curved design ensure comfortable loading and unloading of samples and cleaning of the unit.

- **High Rotor Speed**

- A powerful combination of motor and rotor results in high-speed capacity up to 15000 rpm/21,380 x g for MCV / MCR, 15000 rpm/ 21382 x g for TCV, and 16000 rpm/ 24320 x g for TCR.

- **Large Capacity**

- Diverse specifications of rotors make capacity respectively ranges from 4 x 8 PCR strips (4 x 8 x 0.2 ml) to 44 x 1.5 / 2.0 ml for MCV / MCR, and from 24 x 1.5 ml / 2 ml to 4 x 250 ml (swing-out rotor), and 6 x 250 ml (angle rotor) for TCV / TCR.

- **Incredible Flexibility**

- A wide choice of easy and interchangeable rotors meets all your application needs using microliter, blood, and Falcon type conical tubes. A huge selection of adapters allows centrifugation of practically all commercially available tubes.



## Powerful Refrigeration System (for MCR and TCR)

- **Environment-Friendly Refrigeration Technology**

- Designed with CFC-free refrigeration system, causes no harm to the atmosphere.

- **High Temperature Ramp Rate**

- The compressor in Versati™ centrifuges has strong power, which allows a fast cooling rate. The time cost can be as low as 10 mins when the temperature decreases from room temperature to 4°C.

- **Wide Range of Temperature**

- Versati™ centrifuges does not only have a cooling function, but also a heating function. The temperature range is from -20°C to +40°C.

- **Perfect Performance**

- Swing-bucket rotors of TCR can be spun at maximum speed and still maintain -2°C.

- **Fast Pre-cooling**

- If the samples are temperature-sensitive, it is helpful to precool the centrifuge, the rotor, and eventually the buckets to the needed working temperature. Versati™ centrifuges provide fast precooling function (about 10 mins) that is maintained even when the centrifuge is not in use.

## Superior Safety

- **Genuine-Protect™ Safety Lid Design**

- Lid with motor-driven design ensuring safety of users from accidental release of aerosols and probable misuse.

- **V-balance™ Weight Imbalance Protection**

- Versati™ centrifuges are equipped with active weight imbalance-identification system. In case the rotor is not equally loaded, the drive will turn off during acceleration and the rotor will then decelerate to a stop.

- **Overspeed Protection**

- Equipped with a speed detection system. Once the speed exceeds the safety range, the alarm will sound off, and rotation is halted.

- **Overtemperature Protection**

- With an overtemperature alarm for the chamber, rotor, and frequency converter. Once an overtemperature is detected, the unit will stop running. This provides comprehensive protection which prolongs the life span of the centrifuge.

- **Aerosol-tight and Autoclavable**

- High-quality, extremely robust aluminum lid of rotor allows aerosol-tight centrifugation. Rotor, buckets, lids, and adapters are autoclavable (20 min, 121°C) to ensure sterility of the centrifuge environment.

- **Alarm System**

- Audible and visual alarms are activated during system failures and error message is displayed on LCD for troubleshooting.

- **Safety Standards Followed**

- All models are manufactured according to international safety regulations such as IEC 61010, EN61010-1, EN61010-2-2, ISO 9001, and CE.



## Humanization Designed Versati™ Controller

Versati™ centrifuges with bright back-lit LCD, simple intuitive key entry and unique turning knob for fast value setting are convenient in operation even with gloves on; greatly saves time for users.

### MCR / TCR Model:

Alphanumeric Screen that displays all the parameters and status of the centrifuge.

Set Button - allows to set up the program with accuracy and precaution.

Open Button - allows easy access and one-hand operation of the lid.

Short Button - quick access to centrifugation without entering any set up program.

Store Button - allows all the desired and important settings to be saved.

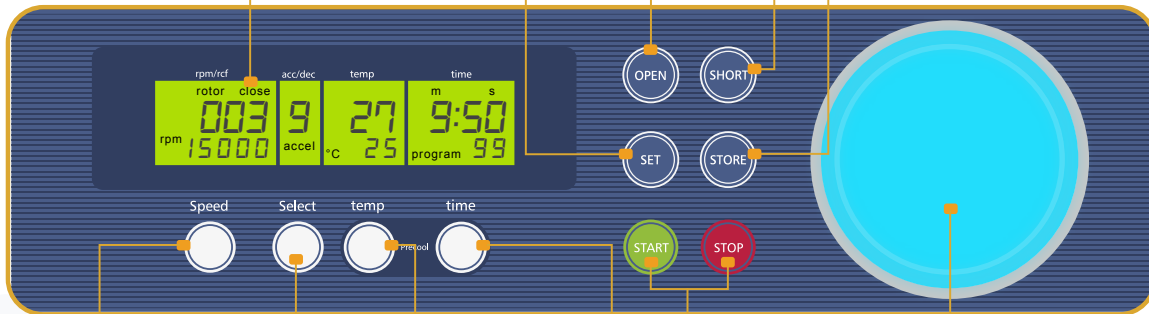

Speed Button - enables user to control the speed and g-force of the centrifugation.

Select Button - allows user to choose the acceleration and deceleration intensity option.

Temperature Button - an option for the refrigerated centrifuge to set the temperature in the chamber.

Time Button - controls the duration of the run.

Start/Stop Button - these buttons give control to the user to start and stop the run.

Adjusting Knob - allows user to navigate and regulate the desired setting for each option of the program.

### MCV / TCV Model:

Alphanumeric screen that displays all the parameters and status of the centrifuge.

Set Button - allows to set up the program with accuracy and precaution.

Open Button - allows easy access and one-hand operation of the lid.

Short Button - quick access to centrifugation without entering any set up program.

Store Button - allows all the desired and important settings to be saved.

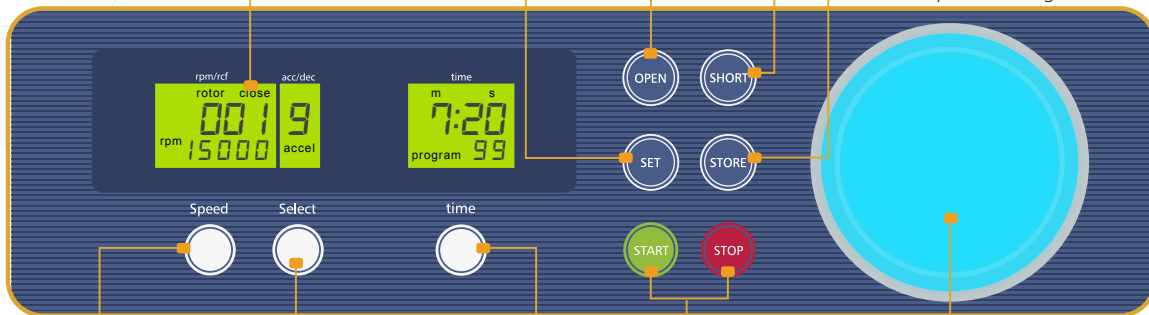

Speed Button - enables user to control the speed and g-force of the centrifugation.

Select Button - allows user to choose the acceleration and deceleration intensity option.

Time Button - controls the duration of the run.

Start/Stop Button - these buttons give control to the user to start and stop the run.

Adjusting Knob - allows user to navigate and regulate the desired setting for each option of the program.

- **Smartdrive™ Rotor Auto Recognition**

- Interchangeable rotors can be automatically recognized (for TCV / TCR only) and each rotor can only be set and run at the permitted maximum speed to protect the motor system with longer lifespan.

- **Large Storage Space**

- Versati™ centrifuges enable the users to edit and store up to 99 programs with a combination of speed, centrifugal force, running time, temperature, acceleration/deceleration rate, radius correction, and rotor code which is enough for all users in a lab. A collection of pre-set values can be saved for quick and easy loading.

- **Various Operation Mode**

- Three types of spin mode: short spin for short-running, **continuous spin** and **time-setting spin** (range from 10 s to 99 h 59 min) can be chosen to suit various applications.

- **Automatic Conversion between Speed and RCF**

- Users can set either the rotor speed or the centrifugal force which is automatically converted by the system from one parameter to another for different requirements.

- **Acceleration/ Deceleration**

- To provide more choices for users to suit their experiment demands, Versati™ centrifuges offer ten different types of acceleration/ deceleration rate options.

- **Notification System**

- Once the run is complete, an audible alarm prompts users to take out samples. It has a total of ten different sounds to choose from.

- **Automatic Switch of Temperature Types**

- Versati™ centrifuges allow automatic conversions of degree Celsius and Fahrenheit.

- **Real-Time Modification of Parameter**

- The parameters like rotary speed, RCF, running time, acceleration/ deceleration rate, and temperature can be adjusted during the operation to improve your working efficiency.

### Guide to Models, Micro Centrifuge

## MCV - 88 - 8

Model	Code	Centrifuge Capacity	Code	Electrical Supply	Code
Micro Centrifuge Ventilated	MCV	Maximum Sample Capacity (ml)	88	230 VAC 50/60 Hz	8
				120 VAC 50/60 Hz	9
Micro Centrifuge Refrigerated	MCR			230 VAC 50/60 Hz	8
				120 VAC 50/60 Hz	9

### MCV / MCR High Speed Micro Centrifuge for up to 15,000 rpm

Designed to accelerate your routine sample preparation processes.

#### ORDERING INFORMATION

Model Code	Item Code	Description
MCV - 88 - 8	2220001	Micro Centrifuge Ventilated 230 VAC, 50/60 Hz
MCV - 88 - 9	2220002	Micro Centrifuge Ventilated 120 VAC, 50/60 Hz
MCR - 88 - 8	2220003	Micro Centrifuge Refrigerated 230 VAC, 50/60 Hz
MCR - 88 - 9	2220004	Micro Centrifuge Refrigerated 120 VAC, 50/60 Hz

### Guide to Models, Tabletop Centrifuge

## TCV - 1500 - 8

Model	Code	Centrifuge Capacity	Code	Electrical Supply	Code
Tabletop Centrifuge Ventilated	TCV	Maximum Sample Capacity (ml)	1500	230 VAC 50/60 Hz	8
				120 VAC 50/60 Hz	9
Tabletop Centrifuge Refrigerated	TCR			230 VAC 50/60 Hz	8
				120 VAC 50/60 Hz	9

### TCV / TCR High Speed Tabletop Centrifuge for up to 16,000 rpm

Ideal for multi-purpose centrifugation at high-speed.

#### ORDERING INFORMATION

Model Code	Item Code	Description
TCV-1500-8	2220005	Tabletop Centrifuge Ventilated 230 VAC, 50/60 Hz
TCV-1500-9	2220006	Tabletop Centrifuge Ventilated 120 VAC, 50/60 Hz
TCR-1500-8	2220007	Tabletop Centrifuge Refrigerated 230 VAC, 50/60 Hz
TCR-1500-9	2220008	Tabletop Centrifuge Refrigerated 120 VAC, 50/60 Hz

# Rotors and Adapters for Centrifuges MCV and MCR

FIXED-ANGLE ROTOR	
Model No.	VST - ROT - 101
Item Code	1380204
Number of Tubes and Tube Capacity	24 x 1.5 / 2.0 ml
Tube type (without adapter)	Conical/ Dome
Acceleration	21 - 152 seconds
Deceleration	18 - 173 seconds
Length	40 mm (1.6")
Angle	45°
Maximum Radius	85 mm (3.4")
Maximum Bore	11 mm $\varnothing$ (0.4" $\varnothing$ )
Maximum RCF	21380 x g
Maximum Speed	15000 rpm
Temperature at Maximum Speed	6°C



- Has available adapters for 0.5 ml, and 0.2 / 0.4 ml PCR tubes.
- Rotor, lid, and adapters are autoclavable (maximum of 121°C, 20 minutes).
- TÜV NORD Bioseal Certified Rotor

Adapter Model No.	VST - ADP - 001	VST - ADP - 002
Item Code	1380013	1380014
Number of Tubes and Tube Capacity	1 x 0.5 ml	1 x 0.4 / 0.2 ml PCR
Tube type (inside the adapter)	Conical	
Adapter type	Flat	
Total Number of Tubes per Rotor	24	
Adapter Bore	8 mm $\varnothing$ (0.3" $\varnothing$ )	6 mm $\varnothing$ (0.2" $\varnothing$ )
Tube Length	45 mm (1.8")	

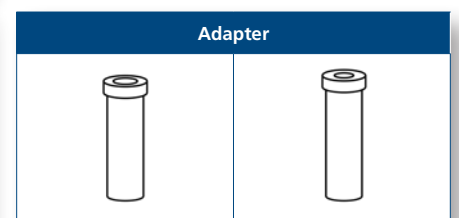

FIXED-ANGLE ROTOR	
Model No.	VST - ROT - 003
Item Code	1380007
Number of Tubes and Tube Capacity	30 x 1.5 / 2.0 ml
Tube type (without adapter)	Conical/ Dome
Acceleration	29 - 235 seconds
Deceleration	27 - 258 seconds
Length	11 mm (0.4")
Angle	45°
Maximum Radius	94 mm (3.7")
Maximum Bore	11 mm $\varnothing$ (0.43" $\varnothing$ )
Maximum RCF	19151 x g
Maximum Speed	13500 rpm
Temperature at Maximum Speed	7°C



- Has available adapters for 0.5 ml, and 0.2 / 0.4 ml PCR tubes.
- Rotor, lid, and adapters are autoclavable (maximum of 121°C, 20 minutes)

Adapter Model No.	VST - ADP - 001	VST - ADP - 002
Item Code	1380013	1380014
Number of Tubes and Tube Capacity	1 x 0.5 ml	1 x 0.4 / 0.2 ml PCR
Tube type (inside the adapter)	Conical	
Adapter type	Flat	
Total Number of Tubes per Rotor	24	
Adapter Bore	8 mm $\varnothing$ (0.3" $\varnothing$ )	6 mm $\varnothing$ (0.2" $\varnothing$ )
Tube Length	45 mm	

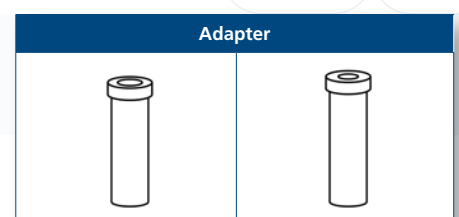

FIXED-ANGLE ROTOR	
Model No.	VST-ROT-004
Item Code	1380008
Number of Tubes and Tube Capacity	44 x 1.5 / 2.0 ml
Tube type (without adapter)	Conical/ Dome
Acceleration	18 - 136 seconds
Deceleration	17 - 133 seconds
Length	11 mm (0.43")
Angle	32° / 55°
Maximum Radius	84 mm (3.30") outer slots / 85 mm (3.34") inner slots
Maximum Bore	11 mm $\varnothing$ (0.43" $\varnothing$ )
Maximum RCF	17113 x g (outer slots) / 17317 x g (inner slots)
Maximum Speed	13500 rpm
Temperature at Maximum Speed	7°C



- Has available adapters for 0.5 ml, and 0.2 / 0.4 ml PCR tubes.
- Rotor, lid, and adapters are autoclavable (maximum of 121°C, 20 minutes).

Adapter Model No.	VST - ADP - 001	VST - ADP - 002
Item code	1380013	1380014
Number of Tubes and Tube Capacity	1 x 0.5 ml	1 x 0.4 / 0.2 ml PCR
Tube type (inside the adapter)	Conical	
Adapter type	Flat	
Total Number of Tubes per Rotor	24	
Adapter Bore	8 mm $\varnothing$ (0.3" $\varnothing$ )	6 mm $\varnothing$ (0.2" $\varnothing$ )
Tube Length	45 mm	

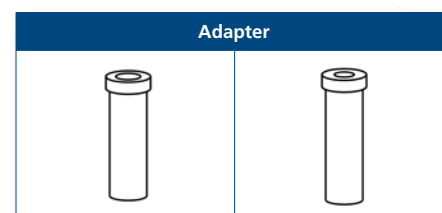

FIXED-ANGLE ROTOR	
Model No.	VST - ROT - 006
Item Code	1380010
Number of Tubes and Tube Capacity	12 x 5 ml
Tube type (without adapter)	Conical
Acceleration	24 - 148 seconds
Deceleration	17 - 320 seconds
Length	60 mm (2.4")
Angle	45°
Maximum Radius	85 mm (3.3")
Maximum Bore	17 mm $\varnothing$ (0.07" $\varnothing$ )
Maximum RCF	19978 x g
Maximum Speed	14500 rpm
Temperature at Maximum Speed	4°C



- Has the largest sample capacity for Versati™ micro centrifuges.
- Has available adapters for 1.0 ml flat cryo tube, 1.8 ml round cryo tube, and 1.5 / 2.0 ml micro tube.
- Rotor, lid, and adapters are autoclavable (maximum of 121°C, 20 minutes).

Adapter Model No.	VST - ADP - 003	VST - ADP - 004	VST - ADP - 005
Item code	1380015	1380016	1380017
Number of Tubes and Tube Capacity	1 x 1.5/2.0 ml	1 x 1.0 ml	1 x 1.8 ml
Tube type (inside the adapter)	Conical/Dome	Flat cryo tube	Dome cryo tube
Adapter type	Holed	Conical	
Total Number of Tubes per Rotor	12		
Adapter Bore	11 mm $\varnothing$ (0.43" $\varnothing$ )	12.6 mm $\varnothing$ (0.5" $\varnothing$ )	
Tube Length	42 mm (1.7")	41 mm (1.6")	48 mm (1.9")

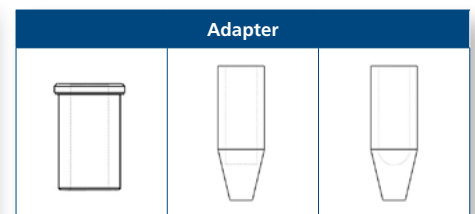

FIXED-ANGLE ROTOR	
Model No.	VST - ROT - 007
Item Code	1380011
PCR Strips	4 x 8 (0.2 ml)
Acceleration	17 - 150 seconds
Deceleration	20 - 95 seconds
Angle	45°
Maximum Radius	61 mm (2.4")
Maximum Bore	6 mm $\varnothing$ (0.2" $\varnothing$ )
Maximum RCF	15343 x g
Maximum Speed	15000 rpm
Temperature at Maximum Speed	2.5°C



- Suitable with 4 x 8 PCR strips; no adapter.
- Rotor and lid are autoclavable (maximum of 121°C, 20 minutes).

HEMATOCRIT ROTOR	
Model No.	VST - ROT - 008
Item Code	1380012
Capillaries	24
Acceleration	15 - 120 seconds
Deceleration	15 - 120 seconds
Angle	90°
Maximum Radius	93 mm (3.7")
Capillary Tube Dimension ( $\varnothing$ x Length)	1.6 x 75 mm
Maximum RCF	14970 x g
Maximum Speed	12000 rpm



- Ideal for medical field in the determination of Hematocrit value.
- Only available to micro ventilated centrifuge (MCV).
- Rotor and lid are autoclavable (maximum of 121°C, 20 minutes).

Model No.	VST - ACS - 005
Item Code	1380075
Description	Reading device for hematocrit value

# Rotors and Adapters for Centrifuges TCV and TCR

SWING-BUCKET ROTOR	
Model No.	VST - ROT - 009
Item Code	1380022
Rotor Max. Capacity	4 x 250 ml
Bucket type	Circular flat-bottom
Acceleration	34 - 309 seconds
Deceleration	36 - 458 seconds
Angle	0-90°
Maximum Radius	167 mm (6.6")
Maximum RCF	3780 x g
Maximum Speed	4500 rpm
Temperature at Maximum Speed	-2°C



- 4 x 250 ml bucket with flexible adapters for bulk sample testing.
- Has available screw cap.
- Ideal for medical and biotechnology laboratories
- Rotor, buckets, and screw caps are autoclavable (maximum 121°C, 20 minutes).

PC - SCREW CAP	
Model No.	VST - ACS - 009
Item Code	1380079



- Screw cap made of Polycarbonate (PC) for VST-ADP-006 to VST-ADP-021 of VST-ROT-009
- Used with O-rings for aerosol-tight application

O-RING	
Model No.	VST - ACS - 010
Item Code	1380080
Description	O-ring for adapter VST-ADP-006 ~ VST-ADP-021

Adapter Model No.	VST - ADP - 006	VST - ADP - 007	VST - ADP - 008
Item code	1380033	1380034	1380035
Number of Tubes and Tube Capacity	1 x 250 ml	1 x 100 ml	3 x 50 ml
Tube type (inside the bucket)	Flat	Dome	
Total Number of Tubes per Rotor	4		12
Adapter Bore	62 mm ø (2.4"ø)	41 mm ø (1.6"ø)	29 mm ø (1.1"ø)
Tube Length	110 / 130 mm (4.3" / 5.1")	95 / 120 mm (3.7" / 4.7")	95 / 120 mm (3.7" / 4.7")

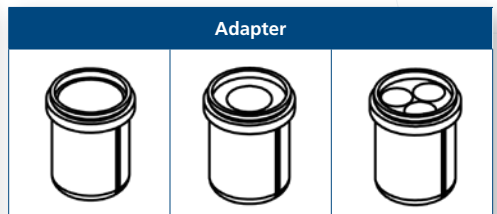

Adapter Model No.	VST - ADP - 009	VST - ADP - 010	VST - ADP - 011
Item code	1380036	1380037	1380038
Number of Tubes and Tube Capacity	5 x 25 ml	9 x 9ml/ 9 x 15ml	3 x 50 ml
Tube type (inside the bucket)	Dome		Conical
Total Number of Tubes per Rotor	20	36	12
Adapter Bore	24.5 mm ø (1.0"ø)	14 / 17 mm ø (0.6" / 0.7"ø)	29 mm ø (1.1"ø)
Tube Length	100 / 120 mm (3.9" / 4.7")	76 / 115 mm (3.0" / 4.5")	100 / 120 mm (3.9" / 4.7")

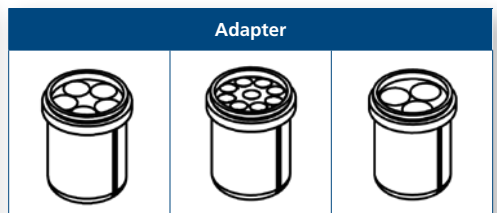

Adapter Model No.	VST - ADP - 012	VST - ADP - 013	VST - ADP - 014
Item code	1380039	1380040	1380041
Number of Tubes and Tube Capacity	2 x 50 ml	7 x 15 ml	1 x 50 ml
Tube type (inside the bucket)	Flat	Conical	Dome
Total Number of Tubes per Rotor	8	28	4
Adapter Bore	29 mm $\varnothing$ rim (1.1" $\varnothing$ rim)	17 mm $\varnothing$ (0.7" $\varnothing$ )	34 mm $\varnothing$ (1.3" $\varnothing$ )
Tube Length	100 / 120 mm (3.9" / 4.7")	95 / 120 mm (3.7" / 4.7")	100 / 120 mm (3.9" / 4.7")

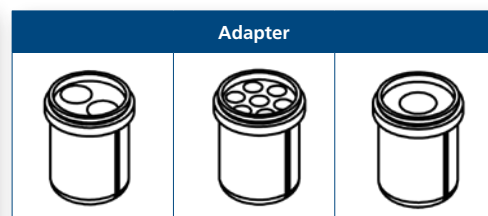

Adapter Model No.	VST - ADP - 015	VST - ADP - 016	VST - ADP - 017
Item code	1380042	1380044	1380043
Number of Tubes and Tube Capacity	1 x 50 ml	3 x 25 ml	7 x 15 ml
Tube type (inside the bucket)	Flat		
Total Number of Tubes per Rotor	4	12	28
Adapter Bore	29 mm $\varnothing$ rim (1.1" $\varnothing$ rim)	24.5 mm $\varnothing$ (1.0" $\varnothing$ )	17 mm $\varnothing$ rim (0.7" $\varnothing$ )
Tube Length	100 / 120 mm (3.9" / 4.7")	85 / 100 mm (3.3" / 3.9")	100 / 120 mm (3.9" / 4.7")

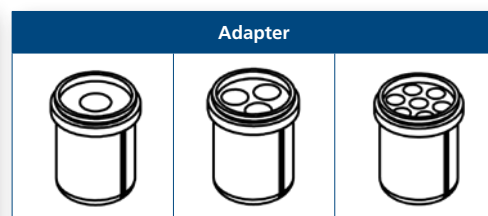

Adapter Model No.	VST - ADP - 018	VST - ADP - 019	VST - ADP - 020
Item code	1380045	1380046	1380047
Number of Tubes and Tube Capacity	8 x 10 ml	14 x 5 - 7 ml	10 x 6 - 7 ml
Tube type (inside the bucket)	Dome		Blood collection tubes
Total Number of Tubes per Rotor	32	56	40
Adapter Bore	16 mm $\varnothing$ rim (0.6" $\varnothing$ rim)	13 mm $\varnothing$ (0.5" $\varnothing$ )	
Tube Length	80 / 100 mm (3.1" / 3.9")	65 / 120 mm (2.6" / 4.7")	75 / 120 mm (3.0" / 4.7")

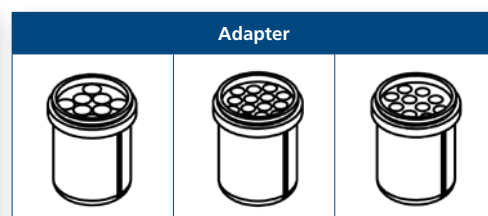

Adapter Model No.	VST - ADP - 021	VST - ADP - 022
Item code	1380048	1380049
Number of Tubes and Tube Capacity	8 x 4 - 10 ml	9 x 1.5 - 2 ml
Tube type (inside the bucket)	Blood collection tubes	Conical/ Dome
Total Number of Tubes per Rotor	32	36
Adapter Bore	16 mm $\varnothing$ (0.6" $\varnothing$ )	11 mm $\varnothing$ (0.4" $\varnothing$ )
Tube Length	75 / 100 mm (3.0" / 3.9")	38 mm (1.5")

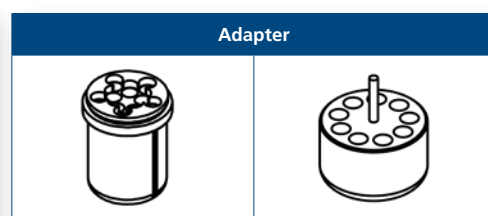

• Used with VST-ADP-006

MICROTITER SWING-BUCKET ROTOR	
Model No.	VST - ROT - 010
Item Code	1380023
Maximum Capacity	2 x 3 MTP
Acceleration	43 - 452 seconds
Deceleration	38 - 616 seconds
Maximum Loading Height	63 mm (2.5")
Maximum Loading Weight	310 g
Angle	0-90°
Maximum Radius	120 mm (4.7")
Maximum RCF	2716 x g
Maximum Speed	4500 rpm
Temperature at Maximum Speed	-3°C



- Has available deep well plate adapter for 48 x 1.5 ml / 2.0 ml micro tubes.
- Rotor and adapters are autoclavable (maximum 121°C, 20 minutes).

Note: Please proceed to page 22 for Esco Microtiter Swing-bucket Rotor Guide

Model No.	VST-ADP-023 (Deep well plate)
Item Code	1380050
Number of Tubes and Tube Capacity	48 x 1.5/2.0 ml (Conical/ Dome)
Bores Diameter	11 mm
Length	40 mm
Total Number of Tubes per Rotor	96

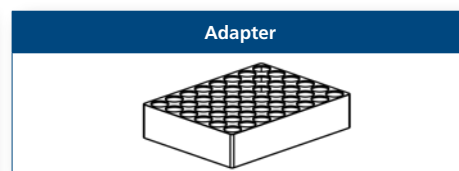

Adapter Model No.	VST - ACS - 012
Item Code	1380082
Description	Replacement carrier for rotor VST-ROT-010

FIXED-ANGLE ROTOR	
Model No.	VST-ROT-102
Item Code	1380205
Number of Tubes and Tube Capacity	24 x 1.5 / 2.0 ml
Tube type (without adapter)	Conical/ Dome
Acceleration	25 - 251 seconds (1.5 ml) 30 - 249 seconds (2.0 ml)
Deceleration	26 - 610 seconds (1.5 ml) 27 - 635 seconds (2.0 ml)
Length	40 mm (1.6")
Angle	45°
Maximum Radius	85 mm (3.3")
Maximum Bore	11 mm $\varnothing$ (0.4" $\varnothing$ )
Maximum RCF	21380 / 24320 x g
Maximum Speed	15000 rpm (TCV) / 16000 rpm (TCR)
Temperature at Maximum Speed	3°C



- Has the highest maximum rpm capacity among the Versati™ Centrifuges.
- Has available adapters for 0.5 ml, and 0.2 / 0.4 ml PCR tubes.
- Rotor, lid, and adapters are autoclavable (maximum of 121°C, 20 minutes).
- TÜV NORD Bioseal Certified Rotor

Adapter Model No.	VST - ADP - 001	VST - ADP - 002
Item code	1380013	1380014
Number of Tubes and Tube Capacity	1 x 0.5 ml	1 x 0.4 / 0.2 ml PCR
Tube type (inside the adapter)	Conical	
Adapter type	Flat	
Total Number of Tubes per Rotor	24	
Adapter Bore	8 mm $\varnothing$ (0.3" $\varnothing$ )	6 mm $\varnothing$ (0.2" $\varnothing$ )
Tube Length	45 mm (1.8")	

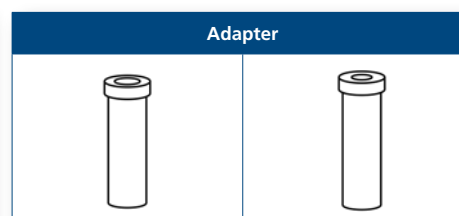



FIXED-ANGLE ROTOR	
Model No.	VST-ROT-013
Item Code	1380026
Number of Tubes and Tube Capacity	6 x 85 ml
Tube type (without adapter)	Dome
Acceleration	85 - 697 seconds
Deceleration	70 - 2313 seconds
Length	113 mm (4.4")
Angle	38°
Maximum Radius	115 mm (4.5")
Maximum Bore	38 mm $\varnothing$ (1.5" $\varnothing$ )
Maximum RCF	15550 x g (TCV) / 21730 x g (TCR)
Maximum Speed	11000 rpm (TCV) / 13000 rpm (TCR)
Temperature at Maximum Speed	6°C



- Has available adapters for 15 ml, 16 ml, 30 ml, and 50 ml tubes.
- Rotor, lid, and adapters are autoclavable (maximum of 121°C, 20 minutes).

Adapter Model No.	VST - ADP - 024	VST - ADP - 025	VST - ADP - 026
Item code	1380051	1380052	1380053
Number of Tubes and Tube Capacity	2 x 15 ml	1 x 15 ml	1 x 30 ml
Tube type (inside the adapter)	Dome		
Adapter type	Dome		
Total Number of Tubes per Rotor	12	6	
Adapter Bore	17 mm $\varnothing$ rim (0.7" $\varnothing$ rim)		25 mm $\varnothing$ (1.0" $\varnothing$ )
Tube Length	95 / 100 mm (3.7" / 3.9")	103 / 110 mm (4.1" / 4.3")	90 / 103 mm (3.5" / 4.1")

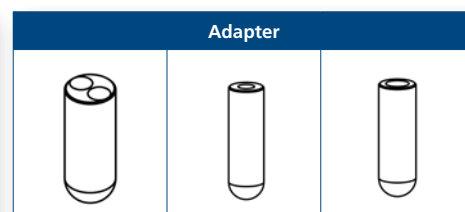

Adapter Model No.	VST - ADP - 027	VST - ADP - 028	VST - ADP - 031
Item code	1380054	1380055	1380058
Number of Tubes and Tube Capacity	1 x 50 ml	1 x 50 ml	1 x 15 ml
Tube type (inside the adapter)	Dome	Conical	
Adapter type	Dome		
Total Number of Tubes per Rotor	6		
Adapter Bore	29 mm $\varnothing$ rim (1.1" $\varnothing$ rim)		17 mm $\varnothing$ (0.7" $\varnothing$ )
Length	105 mm (4.1")	118 mm (4.6")	120 mm (4.7")

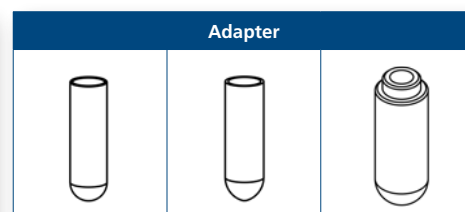

Adapter Model No.	VST - ADP - 032
Item Code	1380059
Number of Tubes and Tube Capacity	1 x 16 ml
Tube type (inside the adapter)	Conical
Adapter type	Dome
Total Number of Tubes per Rotor	6
Adapter Bore	18 mm $\varnothing$ (0.7" $\varnothing$ )
Tube Length	103/110 mm (4.1" / 4.3")

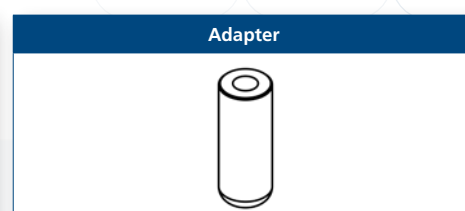

FIXED-ANGLE ROTOR	
Model No.	VST-ROT-014
Item Code	1380027
Number of Tubes and Tube Capacity	30 x 15 ml
Tube type (without adapter)	Conical/ Dome
Acceleration	25 - 149 seconds
Deceleration	20 - 985 seconds
Length	120 mm (4.7")
Angle	35°
Maximum Radius	125 mm (4.9") outer slots / 109 mm (4.3) inner slots
Maximum Bore	17 mm $\varnothing$ (0.7" $\varnothing$ )
Maximum RCF	2830 x g (outer slots) / 2468 x g (inner slots)
Maximum Speed	4500 rpm
Temperature at Maximum Speed	-12°C



- Mainly for hospital use in centrifugation of urine and blood
- Rotor and adapters are autoclavable (maximum of 121°C, 20 minutes).

Adapter Model No.	VST-ADP -003	VST-ADP - 029	VST-ADP - 030
Item code	1380015	1380056	1380057
Number of Tubes and Tube Capacity	1 x 1.5/ 2.0 ml	1 x 4-7 ml	1 x 1.8-5 ml
Tube type (inside the adapter)	Conical/ Dome	Round (vacutainer tube)	
Adapter type	Holed	Dome	
Total No. of Tubes per Rotor	20		
Adapter Bore	11 mm $\varnothing$ (0.43" $\varnothing$ )	13.5 mm $\varnothing$ rim (0.5" $\varnothing$ rim)	
Tube Length	42 mm (1.7")	95 /115 mm (3.7"/4.5")	70/90 mm (2.6"/3.5")

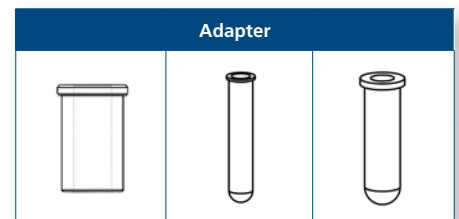

FIXED-ANGLE ROTOR	
Model No.	VST - ROT - 015
Item Code	1380028
Number of Tubes and Tube Capacity	4 x 85 ml
Tube type (without adapter)	Dome
Acceleration	60 - 506 seconds
Deceleration	49 - 1745 seconds
Length	113 mm (4.4")
Angle	30°
Maximum Radius	92 mm (3.6")
Maximum Bore	38 mm $\varnothing$ (1.5" $\varnothing$ )
Maximum RCF	14809 x g
Maximum Speed	12000 rpm
Temperature at Maximum Speed	5°C



- Suitable for bacterial culture in medium tube capacity.
- Rotor, lid, and adapters are autoclavable (maximum of 121°C, 20 minutes).

Adapter Model No.	VST - ADP - 025	VST - ADP - 026	VST - ADP - 027
Item code	1380052	1380053	1380054
Number of Tubes and Tube Capacity	1 x 15 ml	1 x 30 ml	1 x 50 ml
Tube type (inside the adapter)	Dome		
Adapter type	Dome		
Total Number of Tubes per Rotor	4		
Adapter Bore	17 mm $\varnothing$ rim (0.7" $\varnothing$ rim)	25 mm $\varnothing$ (1.0" $\varnothing$ )	29 mm $\varnothing$ (1.14" $\varnothing$ )
Tube Length	103/110 mm (4.1"/4.3")	90 / 103 mm (3.5"/4.3")	105 mm (4.1")

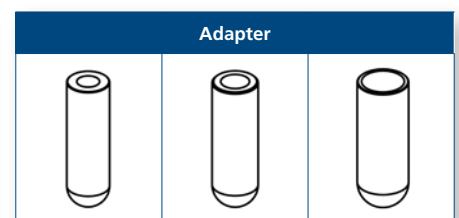

Adapter Model No.	VST - ADP - 028	VST - ADP - 031
Item code	1380055	1380058
Number of Tubes and Tube Capacity	1 x 50 ml	1 x 15 ml
Tube type (inside the adapter)	Conical	
Adapter type	Dome	
Total Number of Tubes per Rotor	4	
Adapter Bore	29 mm $\varnothing$ (1.1" $\varnothing$ )	17 mm $\varnothing$ (0.7" $\varnothing$ )
Tube Length	118 mm (4.6")	120 mm (4.7")

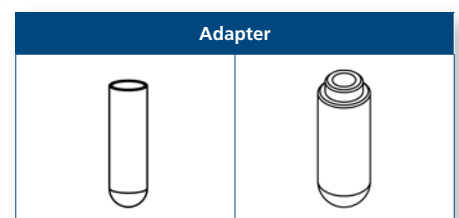

FIXED-ANGLE ROTOR	
Model No.	VST - ROT - 016
Item Code	1380029
Number of Tubes and Tube Capacity	6 x 250 ml
Tube type (without adapter)	Flat
Acceleration	130 - 664 seconds
Deceleration	92 - 2906 seconds
Length	122 mm (4.8")
Angle	28°
Maximum Radius	140 mm (5.5")
Maximum Bore	62 mm $\varnothing$ (2.4" $\varnothing$ )
Maximum RCF	10016 x g
Maximum Speed	8000 rpm
Temperature at Maximum Speed	3°C

Adapter Model No.	VST - ADP - 038	VST - ADP - 039	VST - ADP - 040
Item code	1380065	1380066	1380067
Number of Tubes and Tube Capacity	8 x 1.5 ml	5 x 10 ml	4 x 15 ml
Tube type (inside the adapter)	Conical/ Dome	Dome	Conical
Adapter type	Flat		
Total Number of Tubes per Rotor	48	30	24
Adapter Bore	11 mm $\varnothing$ (0.4" $\varnothing$ )	16 mm (0.6")	17 mm $\varnothing$ (0.7" $\varnothing$ )
Tube Length	40 mm (1.6")	80 mm (3.1")	120 mm (4.7")

Adapter Model No.	VST - ADP - 041	VST - ADP - 042	VST - ADP - 043
Item code	1380068	1380069	1380070
Number of Tubes and Tube Capacity	2 x 30 ml	1 x 50 ml	1 x 50 ml
Tube type (inside the adapter)	Dome		Conical
Adapter type	Flat		
Total Number of Tubes per Rotor	12	6	6
Adapter Bore	26 mm $\varnothing$ rim (1.02" $\varnothing$ )	29 mm $\varnothing$ (1.1" $\varnothing$ )	30 mm $\varnothing$ (1.2" $\varnothing$ )
Tube Length	92 mm (3.6")	103 mm (4.1")	118 mm (4.6")

FIXED-ANGLE ROTOR	
Model No.	VST-ROT-017
Item Code	1380030
Number of Tubes and Tube Capacity	6 x 50 ml
Tube type (without adapter)	Dome
Acceleration	48 - 446 seconds
Deceleration	49 - 1323 seconds
Length	95 / 115 mm (3.7" / 4.5")
Angle	26°
Maximum Radius	84 mm (3.3")
Maximum Bore ( $\varnothing$ mm)	29 mm $\varnothing$ (1.1" $\varnothing$ )
Maximum RCF	15869 x g
Maximum Speed	13000 rpm
Temperature at Maximum Speed	0°C

Adapter Model No.	VST - ADP - 033	VST - ADP - 034	VST - ADP - 035	VST - ADP - 036
Item code	1380060	1380061	1380062	1380064
Number of Tubes and Tube Capacity	1 x 16 ml	1 x 15 ml	1 x 15 ml	1 x 30 ml
Tube type (inside the adapter)	Dome		Conical	Dome
Adapter type	Dome			
Total Number of Tubes per Rotor	6			
Adapter Bore	18 mm $\varnothing$ (0.7" $\varnothing$ )	17 mm $\varnothing$ (0.67" $\varnothing$ )	17.5 mm $\varnothing$ (0.68" $\varnothing$ )	25 mm $\varnothing$ (1.0" $\varnothing$ )
Tube Length	100 / 105 mm (3.9"/4.1")	100/105 mm (3.9"/4.")	116 / 125 mm (4.7"/4.9")	92 / 95 mm (3.6"/3.7")



- The angle rotor of Versati™ Centrifuges with the highest maximum volume capacity.
- Suitable to run large sample tubes.
- Rotor and adapters are autoclavable (maximum of 121°C, 20 minutes).

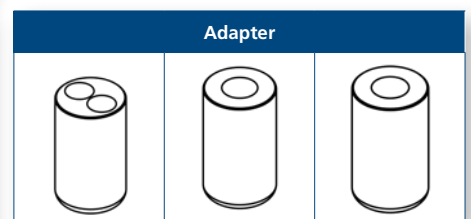
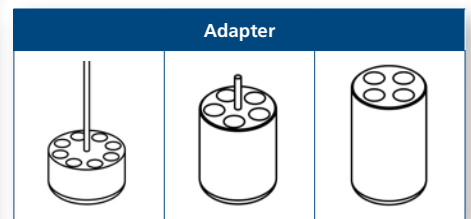

- Can run medium sample volume.
- Has available adapters for 15 ml, 16 ml, and 30 ml tubes.
- Rotor, lid, and adapters are autoclavable (maximum of 121°C, 20 minutes).

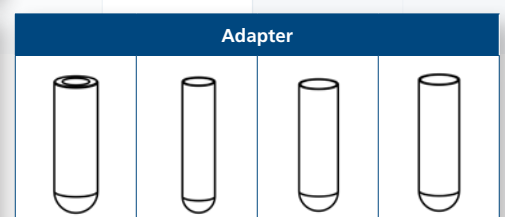

- Used only without rotor lid

FIXED-ANGLE ROTOR	
Model No.	VST-ROT-018
Item Code	1380031
Number of Tubes and Tube Capacity	20 x 10 ml
Tube type (without adapter)	Dome
Acceleration	54 - 512 seconds
Deceleration	47 - 1439 seconds
Length	80 mm (3.1")
Angle	30°
Maximum Radius	98 mm (3.9")
Maximum Bore	16 mm $\varnothing$ (0.6" $\varnothing$ )
Maximum RCF	15775 x g
Maximum Speed	12000 rpm
Temperature at Maximum Speed	0°C



- The angle rotor of Versati™ Centrifuges with the second-lowest temperature at maximum speed.
- Rotor, lid, and adapters are autoclavable (maximum 121°C, 20 mins).

FIXED-ANGLE ROTOR	
Model No.	VST-ROT-019
Item Code	1380032
Number of Tubes and Tube Capacity	10 x 50 ml
Tube type (without adapter)	Conical
Acceleration	115 - 753 seconds
Deceleration	72 - 2395 seconds
Length	118 mm (4.6")
Angle	38°
Maximum Radius	130 mm (5")
Maximum Bore	29 mm $\varnothing$ (1.1" $\varnothing$ )
Maximum RCF	11771 x g (TCV) / 16022 x g (TCR)
Maximum Speed	9000 rpm (TCV) / 10500 rpm (TCR)
Temperature at Maximum Speed	4°C



- The angle rotor that has available adapters for micro tubes, vacutainers, and medium volume sample tubes.
- Rotor, lid, and adapters are autoclavable (maximum 121°C, 20 mins).

Adapter Model No.	VST-ADP-003	VST-ADP-029	VST-ADP-030	VST-ADP-049	VST-ADP-050
Item Code	1380015	1380056	1380057	1380178	1380179
Number of Tubes and Tube Capacity	1 x 1.5/ 2.0 ml	1 x 4-7 ml	1 x 1.8-5 ml	1 x 15 ml	1 x 15 ml
Tube type (inside the adapter)	Conical/ Dome	Round (vacutainer tube)		Conical	Dome
Adapter type	Holed	Dome		Conical	
Total Number of Tubes per Rotor	10				
Adapter Bore	11 mm $\varnothing$ (0.43" $\varnothing$ )	13.5 mm $\varnothing$ rim (0.5" $\varnothing$ rim)		17 mm $\varnothing$ (0.7" $\varnothing$ )	17 mm $\varnothing$ (0.7" $\varnothing$ )
Tube Length	42 mm (1.7")	95 / 115 mm (3.7" / 4.5")	70 / 90 mm (2.6" / 3.5")	120 mm (4.7")	103 / 123 mm (4.1" / 4.8")

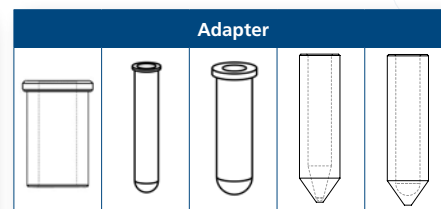

- VST-ADP-049 or VST-ADP-050 is required to use these adapters

SWING-BUCKET ROTOR	
Model No.	VST-ROT-020
Item Code	1380105
Number of Tubes and Tube Capacity	4 x 250 ml
Bucket type	Oval-shaped flat-bottom
Acceleration	34 - 316 seconds
Deceleration	36 - 240 seconds
Angle	0-90°
Maximum Radius	165 mm (6.6")
Maximum RCF	3735 x g
Maximum Speed	4500 rpm
Temperature at Maximum Speed	2°C



- 4 x 250 ml bucket with flexible adapters for bulk sample testing.
- Has available buckets to run more blood collection and medium capacity sample tubes.
- Rotor and buckets are autoclavable (maximum 121°C, 20 minutes).

Adapter Model No.	VST - ADP - 044	VST - ADP - 045
Item Code	1380106	1380107
Number of Tubes and Tube Capacity	4 x 50 ml	10 x 15 ml
Tube type (inside the adapter)	Conical	
Adapter type	Flat	
Total Number of Tubes per Rotor	16	40
Adapter Bore	29 mm $\varnothing$ (1.1" $\varnothing$ )	17 mm $\varnothing$ (0.7" $\varnothing$ )
Tube Length	116 mm (4.6")	121 mm (4.8")

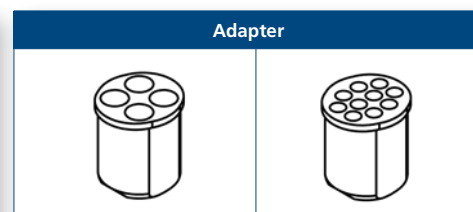

Adapter Model No.	VST - ADP - 046	VST - ADP - 047
Item Code	1380171	1380172
Number of Tubes and Tube Capacity	14 x 1.1-7 ml	12 x 6-10 ml
Tube type (inside the adapter)	Blood collection tubes	
Adapter type	Flat	
Total Number of Tubes per Rotor	56	48
Adapter Bore	13 mm $\varnothing$ (0.5" $\varnothing$ )	16 mm $\varnothing$ (0.6" $\varnothing$ )
Tube Length	75 / 100 mm (3.0" / 3.9")	92 / 100 mm (3.6" / 3.9")

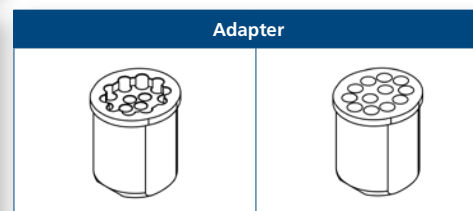

Adapter Model No.	VST - ADP - 022	VST - ADP - 048
Item Code	1380049	1380174
Number of Tubes and Tube Capacity	9 x 1.5 - 2 ml	1 x 250 ml
Tube type (inside the adapter)	Conical/ Dome	Flat
Adapter type	Flat	
Total Number of Tubes per Rotor	36	4
Adapter Bore	11 mm $\varnothing$ (0.4" $\varnothing$ )	62 mm $\varnothing$ (2.4" $\varnothing$ )
Tube Length	38 mm (1.5")	122 mm (4.8")

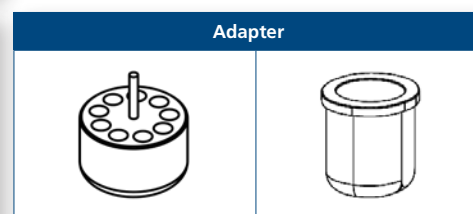

• Used with VST-ADP-048

## TECHNICAL SPECIFICATION

Model	MCV-88-8	MCV-88-9	MCR-88-8	MCR-88-9	TCV-1500-8	TCV-1500-9	TCR-1500-8	TCR-1500-9	
Item Code	2220001	2220002	2220003	2220004	2220005	2220006	2220007	2220008	
External Dimensions (W x D x H)	280 x 389 x 304 mm (11" x 15" x 12")		280 x 563 x 294 mm (11" x 22" x 11.5")		438 x 532 x 374 mm (17" x 21" x 15")		715 x 528 x 373 mm (28" x 20.7" x 15")		
Maximum Relative Centrifugal Force	21380 x g				21382 x g		24320 x g		
Maximum Relative Centrifugal Force Swing-bucket Rotor					3780 x g				
Maximum Speed	15000 rpm				15000 rpm		16000 rpm		
Maximum Volume	44 x 1.5 / 2.0 ml				6 x 250 ml				
Rotor Options	6		5		11				
Speed Range	200 - 15000 rpm				200 - 15000 rpm		200 - 16000 rpm		
Acceleration / Deceleration Rates	10 / 10				10 / 10				
Programs Storage	99				99				
Temperature Range	Ambient		-20°C to +40°C		Ambient		-20°C to 40°C		
Time Set Range	99 hrs 59 mins / 59 min 50 s in 1min / 10s increments / continuous								
Maximum Noise Level (Depending on the rotor)	≤ 62 dB(A)		≤ 59 dB(A)		≤ 68 dB(A)		≤ 64 dB(A)		
Construction	Electrogalvanized steel with Isocide™ antimicrobial powder-coated finish								
	Main Body								Chamber
	Plastic ABS		Stainless steel, grade 304						
Electrical Configuration	270 W 230 VAC, 50/60 Hz	280 W 120 VAC, 50/60 Hz	500 W 230 VAC, 50/60 Hz	560 W 120 VAC, 50/60 Hz	530 W 230 VAC, 50/60 Hz	520 W 120 VAC, 50/60 Hz	785 W 230 VAC, 50/60 Hz	850 W 120 VAC, 50/60 Hz	
Net Weight	17 kg (37 lbs)		35 kg (77 lbs)		49 kg (108 lbs)		73 kg (161 lbs)		
Shipping Weight	22 kg (49 lbs)		40 kg (88 lbs)		56 kg (123 lbs)		80 kg (176 lbs)		
Shipping Dimension (W x D x H)	650 x 670 x 550 mm (25.6" x 26.4" x 21.7")		410 x 680 x 400 mm (16.1" x 26.8" x 15.7")		720 x 860 x 690 mm (28.3" x 33.9" x 27.2")		830 x 650 x 580 mm (32.7" x 25.6" x 22.8")		
Shipping Volume, Maximum	0.24 m <sup>3</sup> (8.5 ft <sup>3</sup> )		0.11 m <sup>3</sup> (3.9 ft <sup>3</sup> )		0.42 m <sup>3</sup> (14.8 ft <sup>3</sup> )		0.31 m <sup>3</sup> (10.9 ft <sup>3</sup> )		

# Noise Level per Rotor

Micro Centrifuge (Ventilated)	
Rotor No.	Noise Level
VST-ROT-101	≤ 58 dBA
VST-ROT-003	≤ 59 dBA
VST-ROT-004	≤ 60 dBA
VST-ROT-006	≤ 53 dBA
VST-ROT-007	≤ 57 dBA
VST-ROT-008	≤ 62 dBA

Micro Centrifuge (Refrigerated)	
Rotor No.	Noise Level
VST-ROT-101	≤ 58 dBA
VST-ROT-003	≤ 58 dBA
VST-ROT-004	≤ 59 dBA
VST-ROT-006	≤ 52 dBA
VST-ROT-007	≤ 56 dBA

Tabletop Centrifuge (Ventilated)	
Rotor No.	Noise Level
VST-ROT-009	≤ 67 dBA
VST-ROT-010	≤ 65 dBA
VST-ROT-102	≤ 60 dBA
VST-ROT-013	≤ 61 dBA
VST-ROT-014	≤ 54 dBA
VST-ROT-015	≤ 59 dBA
VST-ROT-016	≤ 68 dBA
VST-ROT-017	≤ 57 dBA
VST-ROT-018	≤ 57 dBA
VST-ROT-019	≤ 67 dBA
VST-ROT-020	≤ 57 dBA

Tabletop Centrifuge (Refrigerated)	
Rotor No.	Noise Level
VST-ROT-009	≤ 56 dBA
VST-ROT-010	≤ 56 dBA
VST-ROT-102	≤ 60 dBA
VST-ROT-013	≤ 57 dBA
VST-ROT-014	≤ 56 dBA
VST-ROT-015	≤ 59 dBA
VST-ROT-016	≤ 55 dBA
VST-ROT-017	≤ 64 dBA
VST-ROT-018	≤ 57 dBA
VST-ROT-019	≤ 54 dBA
VST-ROT-020	≤ 55 dBA

# Esco Microtiter Swing-bucket Rotor Guide

VST-ROT-010



TYPE	Microtiter Plate	Microtiter Plate (with lid)	Culture Plate	*Deep Well Plate	Microsonic System	Microtest/Terasaki Plate	PCR Plate (96-well)	PCR Strip
Dimensions (WxDxH)	128 x 86 x 15 mm	128 x 86 x 17.5 mm	128 x 86 x 22 mm	128 x 86 x 44.5 mm	128 x 86 x 46 mm	84 x 59 x 11 mm	124 x 82 x 20 mm	-
Plates / Strips per Rotor	6	6	4	2	2	4	2	24 x 8
Max. Loading Weight (per carrier)	310 g							
Max. Loading Height	63 mm							

\*Available in Esco (Item code: 1380050).

# Industries where Laboratory Centrifuges are used:



# ESCO LIFESCIENCES GROUP

42 LOCATIONS IN 21 COUNTRIES ALL OVER THE WORLD

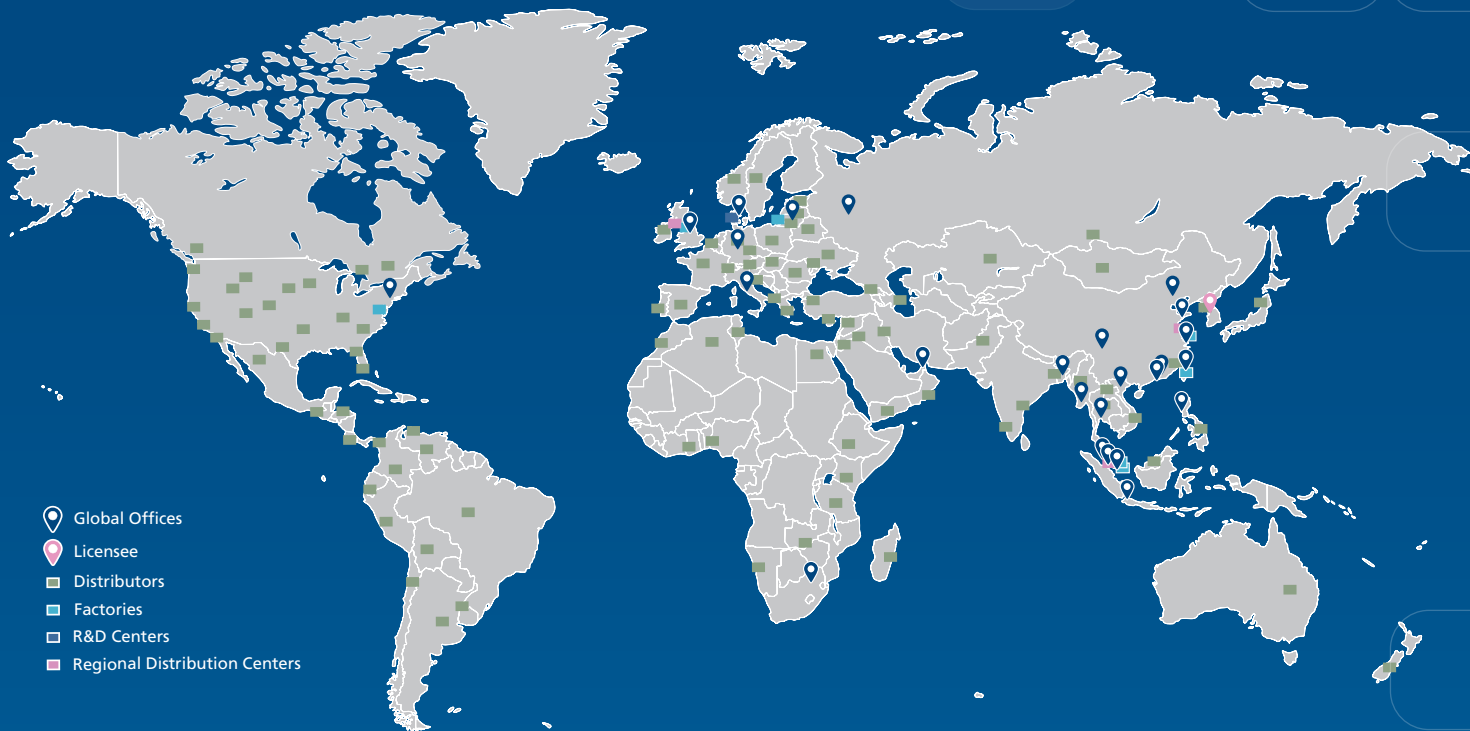

- Global Offices
- Licensee
- Distributors
- Factories
- R&D Centers
- Regional Distribution Centers

*Follow us on social media, download our apps,  
and scan the QR code for more info.*



@EscoLifesciences



@EscoLifesciences



@EscoLifesci



@Esco



@EscoLifesciences



@EscoLifesciences



Esco Lifesciences



Esco Lifesciences

# ESCO

LIFESCIENCES GROUP

Esco Micro Pte. Ltd. • 21 Changi South Street 1 • Singapore 486 777  
Tel: +65 6542 0833 • mail@escolifesciences.com  
www.escolifesciences.com

Esco Technologies, Inc. • 903 Sheehy Drive, Suite F, Horsham, PA 19044, USA  
Tel: +1 215-441-9661 • Fax 484-698-7757  
eti.admin@escolifesciences.com

Esco Lifesciences Group Offices: Bangladesh | China | Denmark | Germany | Hong Kong | India | Indonesia | Italy | Japan | Lithuania  
| Malaysia | Myanmar | Philippines | Russia | Singapore | South Africa | South Korea | Taiwan | Thailand | UAE | UK | USA | Vietnam